



EXTENDED EXPENSE & LABOR PROTECTION PLAN WITH ENHANCED PRODUCT WARRANTY



Liner Guard is a cooperative effort between participating dealers and The Vinyl Works®. This Protection Plan offers years of security to cover the possibility that your retail customers' Vinyl Works® liner needs replacing due to a warranty-covered defect.

The program allows you to sell this extra value to retail customers at a profit or simply include it in the contract price – helping to garner sales. It's protection for your company that you can pass on to retail customers. The choice is yours on how this plan works for you!

Simply by using extended labor and expense protection from you, plus an enhanced product warranty from The Vinyl Works® as incentive, we foresee success offering 'security' as an added feature to entice the consumer to do business with your company. This incentive will help separate Liner Guard protected companies from the competition both on new pool sales and replacement liner jobs.

With Liner Guard, you will be able to offer labor and expense protection for up to 5 years and an enhanced liner product warranty up to 20 years prorated with the first 5 years covered in full.

We offer 4 Levels of available  coverage (*Diamond*, *Platinum*, *Gold* and *Silver*) that are purchased from us after filling out and signing **The Vinyl Works, Inc®. Extended Service Contract**.

- *Diamond Extended Service Contract* offers up to \$3000.00 of eligible reimbursement.
- *Platinum Extended Service Contract* offers up to \$2000.00 of eligible reimbursement.
- *Gold Extended Service Contract* offers up to \$1500.00 of eligible reimbursement.
- *Silver Extended Service Contract* offers up to \$1000.00 of eligible reimbursement.

**See Contract for complete details.*

Note: If you are currently signed up for this Protection Plan and would like to switch to a different level, you are required to fill out a new contract and also notify us in writing of your intentions to cancel the existing signed contract.

If you choose to offer this Extended Labor Protection Plan in your retail sales contract, it is highly suggested that you consult with an attorney to formulate the correct language and any necessary disclaimers needed for your company.

The Vinyl Works Warranty Department



THE VINYL WORKS, INC[®] EXTENDED SERVICE CONTRACT



1. The Extended Service Contract will apply to all in-ground liners purchased from the effective contract date. Contract will renew automatically each year unless either party notifies each other in writing. Contract price is subject to price increases as deemed necessary with 30 day minimum notification.
2. All expenses submitted for reimbursement must be accompanied by an Extended Service Contract Claim Form. This Form must be supported by proper receipts and/or invoices from applicable entities performing labor or providing material. Claim and receipts must not exceed the coverage amount.

The Extended Service Contract applies to:

- a) *In-ground liners found to be defective under the terms of The Vinyl Works 'Limited Warranty for Residential Swimming Pool Liners'*
- b) *In-ground liners with fabrication mistake or shop/clerical error only when original order is submitted in writing on a Vinyl Works Order Form. Verbal orders will not be accepted.*

Acceptable expenses eligible for reimbursement:

- *Labor to remove defective liner*
- *Labor to install new liner*
- *Materials needed to prepare pool bottom for new liner installation*
- *Water to fill pool*
- *Chemicals to balance new pool water*
- *Freight charges for new liner*

LINER EXTENDED SERVICE CONTRACT OPTIONS

Item # VWESCS	SILVER "Extended Service Contract" - \$50.00 NET FEE provides up to \$1000.00 in expenses within 3 years of purchase. _____ <i>Initial here</i>
Item # VWESCG	GOLD "Extended Service Contract" - \$70.00 NET FEE provides up to \$1500.00 in expenses within 5 years of purchase. _____ <i>Initial here</i>
Item # VWESCP	PLATINUM "Extended Service Contract" - \$90.00 NET FEE provides up to \$2000.00 in expenses within 5 years of purchase. _____ <i>Initial here</i>
Item # VWESCD	DIAMOND "Extended Service Contract" - \$150.00 NET FEE provides up to \$3000.00 in expenses within 5 years of purchase. _____ <i>Initial here</i>

LINER FABRICATION ERROR REIMBURSEMENT (Limited)

Detectable and Concealed

1) Detectable Error

If a liner is made incorrectly due to a fabrication, shop or clerical error by The Vinyl Works and is detectable prior to installation, reimbursement is covered under "Liner Fabrication Detectable Error".

Example: Vinyl stair ordered in 'Left' position and box/packing slip indicates 'Right' position. STOP- DO NOT INSTALL.

» What You Can Expect

If considered a 'Detectable Error', a \$250.00 credit will be issued immediately. No claim form, freight bills or expense documentation are required and will not be accepted.

Continue -->

2) Concealed Error

If a liner is made incorrectly due to fabrication, shop or clerical error by The Vinyl Works and is only detectable while attempting to install liner, reimbursement is covered under same provisions as 'Liner Defect Reimbursement'.

Example: Liner ordered in 6' depth, box/packing slip indicates 6' depth but liner fabricated in 8' depth.

» What You Can Expect

If considered a 'Concealed Error', it will be treated as a 'Defect' and would be eligible for expense reimbursement.

Dealer Responsibilities:

- » Order must be submitted in writing using Vinyl Works Order Form.
- » Confirm liner received is consistent with order placed.
- » If information on box/packing slip is incorrect vs. order sent, STOP- DO NOT INSTALL.

Always check for accuracy: the liner pattern, mil; stair, cuddle cove, bench color or location; and dig dimensions or any applicable information. Inspection is your responsibility regardless of who receives the liner into your inventory. New or untrained personnel or subcontractor does not waive this responsibility.

Terms & Conditions:

1. *Extended Service Warranty is effective only on A) in-ground liners installed in a consumer's pool that is found to be defective under the terms of the Vinyl Works Warranty. A defect is defined as a seam de-lamination caused by an improper sealing of the seams. B) A mistake in fabrication; or a shop or clerical error recognized to be the fault of the Vinyl Works and original order was submitted in writing on Vinyl Works order form.*
2. *Claim must be submitted within 90 days of replacement installation, using LinerGuard claim form.*
3. *Contract price will be charged to each liner invoice as a separate line item as a NET figure. (Not discountable)*
4. *All liner specifications such as color/pattern, mil, dimensions, stair/bench location are the dealer's responsibility to confirm as ordered before installing the vinyl liner.*
5. *Acceptable expenses eligible for reimbursement exclude any repairs to pool walls, structure and coping.*
6. *The Vinyl Works retains the right to determine what is a fair and customary fee for work performed and materials provided in replacing defective liner.*
7. *All Vinyl Works liners are packaged with an Owners Manual and Warranty. Failure to comply with installation instruction, proper care or warranty terms voids this contract.*
8. *Dealer agrees to deliver Owners Manual supplied in liner box to retail consumer.*
9. *If a liner is replaced under the terms of this contract, a new "Extended Service Contract" is required for the new liner.*
10. *This contract is non-transferable and is enforceable only by the original contract dealer signee listed below.*
11. *The "Time of Purchase" is defined as the invoice date.*
12. *Reimbursement will be applied as a credit to dealer account.*

DEALER INFORMATION

Company Name: _____

City, State, Zip: _____

Principals Name: _____

Principals Signature: _____

Date: _____

Contact Name: _____

Contact Email: _____

VINYL WORKS INC.

Rep. Name: _____

Rep. Signature: _____

Date: _____



SPECIAL LINER REPLACEMENT PROCEDURES



In an effort to improve quality, process, and standards, The Vinyl Works® will be instituting a liner replacement protocol. Our primary goal is to improve both the quality of products and satisfaction of our mutually shared Retail Customers; at the same time preserving the reputation and relationship we share with our partners, the Pool Professionals. Installing and manufacturing multiple liners hurts all parties involved, both in time, treasure, and reputation, so getting the second liner correct is crucial.

When reporting a special liner fit issue, a second liner will not be manufactured until all manufacturing and installation issues are thoroughly investigated. Examining all possibilities for why the first liner did not fit will be standard procedure. Establishing the necessary changes needed to put the replacement liner into production is essential to authorizing remanufacturing. Outlined below is the systematic approach that will be used to investigate what changes need to be made so the replacement liner will fit and be scheduled for manufacturing.

1. Upon identification of issue, call or email The Vinyl Works® Corporate Services Department with the liner order number, job name, and liner serial lot number. Explain the problem with liner fit. ***Ideally this process will begin with a jobsite call happening in real time when liner fit issue is identified, which will result in the most expedited services.***
2. Provide The Vinyl Works® with pictures showing the liner installed in the pool with the vacuum turned on and detailing problem area or areas. (If the pool is filled with water, take pictures showing this.)
3. After reviewing all of the information that we have, ***a Manager or Department Head will call you directly and explain*** what The Vinyl Works® needs so we can figure out what is causing the fit issues with this liner.
4. It may require that the pool be remeasured using our On-Point/Pool Measure Pro App or doing an A/B measurement procedure using the paper-based method. If the issues are in a Stair, Sundeck, Bench or Cuddle Cove, completely new measurements will be needed. We must confirm that these products have been installed square, level, and with the correct finished dimensions as required for proper liner fit. We may send CAD drawings made for these products without any measurements on them, just blank spots indicating what we need measured. ***If deemed necessary, it may be required to report from the jobsite, so The Vinyl Works® can instruct the dealer on gathering the information needed for a proper fit. This will not be an option. (When required, pictures and/or videos can be sent via Text, FaceTime or Email.)***
5. Liner Warranties and/or Liner Guard Extended Protection Claim Reimbursements will be conditional on the participation and results of this new procedure.

If you have any questions regarding these procedures, please let us know.

We thank you in advance for your cooperation.



EXTENDED SERVICE CONTRACT CLAIM FORM



Date: _____

Dealer Information

Company Name: _____ Customer #: _____
 City/State/Zip: _____
 Contact Person: _____
 Phone #: _____
 E-mail: _____

Retail Consumer Information

Job Name: _____

Expense Information

Labor to Remove and Install: \$ _____ (Total of attached Receipts)
 Water to Fill: \$ _____ (Total of attached Receipts)
 Materials to Prepare Bottom: \$ _____ (Total of attached Receipts)
 Freight: \$ _____ (Total of attached Receipts)
 Chemicals: \$ _____ (Total of attached Receipts)
 Miscellaneous: \$ _____ (Total of attached Receipts)
 Total: \$ _____ (Total of attached Receipts)

Liner Information

Original Invoice #: _____
 Liner Serial/Production #: _____
 Credit Invoice #: _____

Submission: Claim Form and all applicable documentation and receipts must be submitted within 90 days of replacement installation.

Send To:
 The Vinyl Works Inc.
 Corporate Services/Warranty Dept.
 33 Wade Rd.
 Latham, NY 12110

Extended Service Contract Applicable

Diamond Platinum Gold Silver

Authorization: _____ Date: _____



5/20 Limited Warranty

Vinyl Works Inground Residential Swimming Pool Liners

The Vinyl Works Inc.
Corporate Services/Warranty Dept.
33 Wade Rd., Latham, NY 12110



ELITE LEVEL

- Date Warranty Begins**
 - The warranty begins on the date of installation.
 - This product is warranted by Vinyl Works, Inc. to the original purchaser only against failure resulting from workmanship in welding seams and edges for Twenty (20) years, with the replacement cost to be prorated after the fifth (5th) year.
- What is Covered**
 - This warranty applies only to liners purchased for private residential use.
 - The pro rata replacement schedule are the following percentages of the fabricator's current suggested list price. The percentages are based on the length of time you have owned your liner measured from the date of installation:

Within 5 years.....No Charge	After 6 years..... 60%	8-20 years80%
After 5 years.....50%	After 7 years..... 70%	
- What is Not Covered**
 - This warranty does not cover damage caused by shipping, mishandling, faulty installation, improper acts of others, or acts of God.
 - This warranty specifically excludes holes, cuts, tears along seams, bleaching, and wrinkles, which develop over time. These conditions are caused by misuse, improper installation, improper addition of chemicals, or poor maintenance of pool water chemical balance. Your liner must be installed according to the directions and properly maintained.
 - This warranty does not cover chemical related damage sustained in pools with automatic pool covers.
 - This warranty does not cover damage including fading resulting from improper use of (Salt) Chlorine Generators.
 - This warranty does not cover the abrasion of pool liner print caused by automatic pool cleaners.
 - This warranty does not cover ice damage.
 - This warranty does not cover any failures due to material defects. Material used to fabricate this pool liner was not produced by Vinyl Works, Inc. Failures are to be referred to the manufacturer of such material.
 - This warranty does not cover normal fading of color, or microbiological staining. All colored vinyl products, subjected to direct rays of the sun, may fade in time. Such fading, or microbiological staining, does not qualify as a material defect. Staining or fading does not affect the ability of the vinyl to perform its intended function.
 - This warranty does not cover irregularities, imperfections, or damage, which may result from the removal of water from the liner. You should keep the pool full of water at all times.
 - This warranty is null and void if alterations are made to the pool design or if accessories that can cause damage to the liner are used.
- What We Will Do For You**
 - We will replace or repair, according to the pro rata schedule, any liner found to be defective. Charges for shipping, removal, installation, water, and service calls are not covered by this warranty.
 - Replacement will be completed within 10 business days of confirmation of the defect and receipt of your payment, if required.
- How To Obtain Warranty Service**
 - If your liner should fail within the first five years, please contact the dealer you purchased the liner from originally. If your liner should fail after year five please send a letter or e-mail to our factory identifying the liner and date of installation, along with proof of purchase and photograph of failure to: Imperial Pools Inc. 33 Wade Road Latham, NY 12110 Email - info@imperialpools.com
 - Determination of the claimed defect may be made upon receipt of the liner at our factory. At our option, confirmation may be made by an authorized representative at the pool site.
 - All warranty claims must be made directly with Vinyl Works, Inc., and no merchandise is to be returned to us without prior written authorization.
- Disclaimer of Consequential Damages**
 - Under no circumstances will The Vinyl Works, Inc. become liable for *Special, Incidental or Consequential Damages*. This includes but is not limited to *Any Damages for Loss of use of Pool, Injury To, Or Death Of, Any Person/Persons, Or Damage to Property. Any Claims Therefore are Hereby Specifically Disclaimed and Excluded.* Some states do not allow the exclusion of special, incidental or consequential damages, so this above limitation may not apply to you.
- Limitations of Warranties**
 - This warranty shall be unenforceable if you are in default under the terms of any agreement executed in connection with the purchase or installation of this liner.
 - This warranty is intended to be in lieu of any and all warranties expressed or implied. It is a complete statement of our obligation.
 - No agent or dealer or other individual is authorized to change this warranty and any such change will not be recognized by Vinyl Works, Inc.
 - This warranty gives you specific legal rights. You also have implied warranty rights, and may have other rights which vary from state to state. In the event of a problem with warranty service or performance, you may be able to go to small claims court, state court, or federal court.
 - This warranty is in compliance with the Consumer Product Warranty and Federal Trade Commission Improvement Act.

Serial Production No. _____

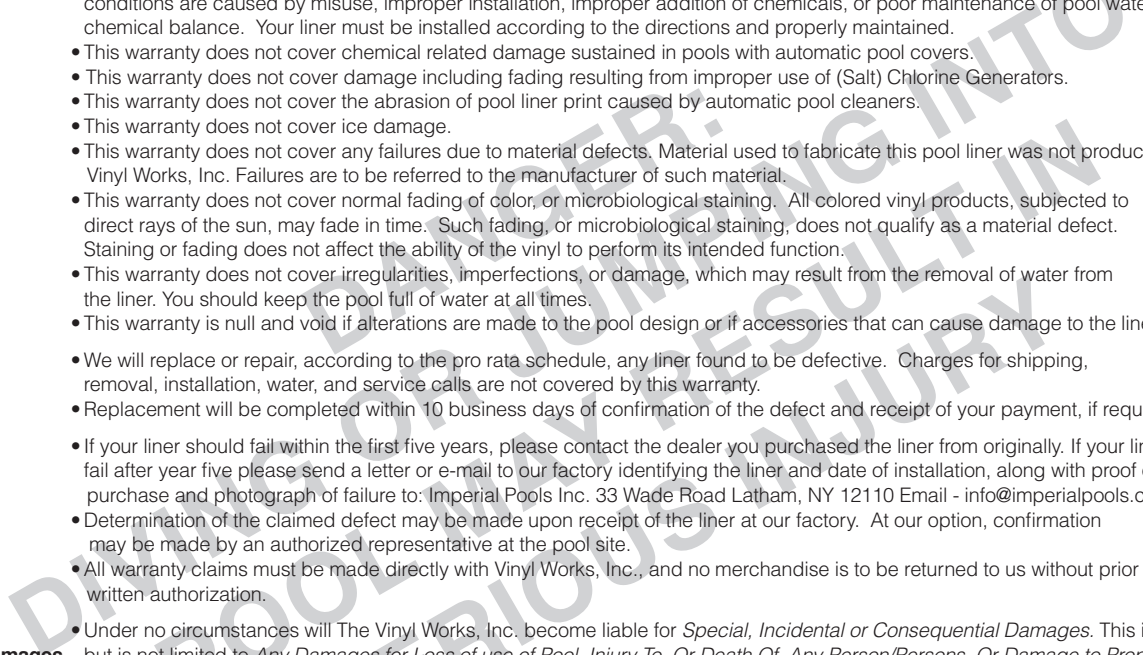

THE VINYL WORKS INGROUND RESIDENTIAL SWIMMING POOL LINER WARRANTY REGISTRATION

To The Purchaser: Please complete this form, detach and mail with proper postage within 30 days after installation. Unless this registration is completed and returned within this period, the liner will not be subject to warranty.

I HAVE RECEIVED AND REVIEWED THE SAFETY INFORMATION PROVIDED:

- | | | |
|--|---|---------------------------------------|
| <i>Pool Owners Manual</i> | <i>"The Sensible Way To Enjoy Your Inground Swimming Pool" Booklet</i> | <i>"Layers of Protection" Booklet</i> |
| <i>"Children Aren't Waterproof" Pamphlet</i> | <i>"Pool And Spa Emergency Procedures for Infants and Children" Booklet</i> | <i>"No Diving" Labels</i> |
| <i>"Safety" Sign</i> | <i>"Plan Your Dive, Steer Up" Pamphlet *</i> | <i>"Warning" Label *</i> |

Owner's Name _____ Date of Installation _____
 Address _____ Purchased From _____
 City _____ State _____ Zip Code _____
 Owner's Signature _____ Installed By _____

****Register your warranty online by going to mypoollinerregistration.com**

Serial Production No. _____

*Only given with pools approved for use with manufactured diving equipment, per ANSI/APSP/ICC-5 2011 & ISPSC2018 Standard for Residential Inground Swimming Pools



3/20 Limited Warranty

Vinyl Works Inground Residential Swimming Pool Liners

The Vinyl Works Inc.
Corporate Services/Warranty Dept.
33 Wade Rd., Latham, NY 12110



SILVER LEVEL

- Date Warranty Begins**
- The warranty begins on the date of installation.
 - This product is warranted by Vinyl Works, Inc. to the original purchaser only against failure resulting from workmanship in welding seams and edges for Twenty (20) years, with the replacement cost to be prorated after the third (3rd) year.
- What is Covered**
- This warranty applies only to liners purchased for private residential use.
 - The pro rata replacement schedule are the following percentages of the fabricator's current suggested list price. The percentages are based on the length of time you have owned your liner measured from the date of installation:

Within 3 years.....No Charge	After 5 years..... 50%	After 7 years.....70%
After 3 years.....30%	After 6 years..... 60%	8-20 years.....80%
After 4 years.....40%		
- What is Not Covered**
- This warranty does not cover damage caused by shipping, mishandling, faulty installation, improper acts of others, or acts of God.
 - This warranty specifically excludes holes, cuts, tears along seams, bleaching, and wrinkles, which develop over time. These conditions are caused by misuse, improper installation, improper addition of chemicals, or poor maintenance of pool water chemical balance. Your liner must be installed according to the directions and properly maintained.
 - This warranty does not cover chemical related damage sustained in pools with automatic pool covers.
 - This warranty does not cover damage including fading resulting from improper use of (Salt) Chlorine Generators.
 - This warranty does not cover the abrasion of pool liner print caused by automatic pool cleaners.
 - This warranty does not cover ice damage.
 - This warranty does not cover any failures due to material defects. Material used to fabricate this pool liner was not produced by Vinyl Works, Inc. Failures are to be referred to the manufacturer of such material.
 - This warranty does not cover normal fading of color, or microbiological staining. All colored vinyl products, subjected to direct rays of the sun, may fade in time. Such fading, or microbiological staining, does not qualify as a material defect. Staining or fading does not affect the ability of the vinyl to perform its intended function.
 - This warranty does not cover irregularities, imperfections, or damage, which may result from the removal of water from the liner. You should keep the pool full of water at all times.
 - This warranty is null and void if alterations are made to the pool design or if accessories that can cause damage to the liner are used.
- What We Will Do For You**
- We will replace or repair, according to the pro rata schedule, any liner found to be defective. Charges for shipping, removal, installation, water, and service calls are not covered by this warranty.
 - Replacement will be completed within 10 business days of confirmation of the defect and receipt of your payment, if required.
- How To Obtain Warranty Service**
- If your liner should fail within the first three years, please contact the dealer you purchased the liner from originally. If your liner should fail after year three please send a letter or e-mail to our factory identifying the liner and date of installation, along with proof of purchase and photograph of failure to: Imperial Pools Inc. 33 Wade Road Latham, NY 12110 Email - info@imperialpools.com
 - Determination of the claimed defect may be made upon receipt of the liner at our factory. At our option, confirmation may be made by an authorized representative at the pool site.
 - All warranty claims must be made directly with Vinyl Works, Inc., and no merchandise is to be returned to us without prior written authorization.
- Disclaimer of Consequential Damages**
- Under no circumstances will The Vinyl Works, Inc. become liable for *Special, Incidental or Consequential Damages*. This includes but is not limited to *Any Damages for Loss of use of Pool, Injury To, Or Death Of, Any Person/Persons, Or Damage to Property. Any Claims Therefore are Hereby Specifically Disclaimed and Excluded.* Some states do not allow the exclusion of special, incidental or consequential damages, so this above limitation may not apply to you.
- Limitations of Warranties**
- This warranty shall be unenforceable if you are in default under the terms of any agreement executed in connection with the purchase or installation of this liner.
 - This warranty is intended to be in lieu of any and all warranties expressed or implied. It is a complete statement of our obligation.
 - No agent or dealer or other individual is authorized to change this warranty and any such change will not be recognized by Vinyl Works, Inc.
 - This warranty gives you specific legal rights. You also have implied warranty rights, and may have other rights which vary from state to state. In the event of a problem with warranty service or performance, you may be able to go to small claims court, state court, or federal court.
 - This warranty is in compliance with the Consumer Product Warranty and Federal Trade Commission Improvement Act.

Serial Production No. _____

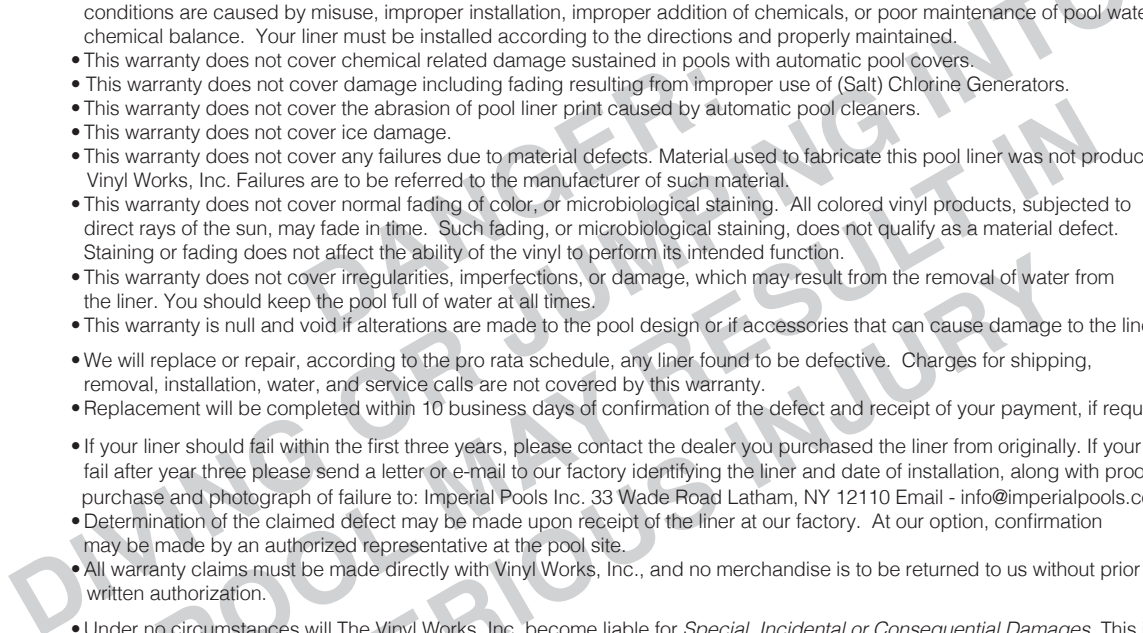

THE VINYL WORKS INGROUND RESIDENTIAL SWIMMING POOL LINER WARRANTY REGISTRATION

To The Purchaser: Please complete this form, detach and mail with proper postage within 30 days after installation. Unless this registration is completed and returned within this period, the liner will not be subject to warranty.

I HAVE RECEIVED AND REVIEWED THE SAFETY INFORMATION PROVIDED:

- | | | |
|--|---|---------------------------------------|
| <i>Pool Owners Manual</i> | <i>"The Sensible Way To Enjoy Your Inground Swimming Pool" Booklet</i> | <i>"Layers of Protection" Booklet</i> |
| <i>"Children Aren't Waterproof" Pamphlet</i> | <i>"Pool And Spa Emergency Procedures for Infants and Children" Booklet</i> | <i>"No Diving" Labels</i> |
| <i>"Safety" Sign</i> | <i>"Plan Your Dive, Steer Up" Pamphlet *</i> | <i>"Warning" Label *</i> |

Owner's Name _____ Date of Installation _____
 Address _____ Purchased From _____
 City _____ State _____ Zip Code _____
 Owner's Signature _____ Installed By _____

****Register your warranty online by going to mypoollinerregistration.com**

Serial Production No. _____

*Only given with pools approved for use with manufactured diving equipment, per ANSI/APSP/ICC-5 2011 Standard for Residential Inground Swimming Pools

Orders can be e-mailed to
LinerOrder@TheVinylWorks.com

- QUOTE ORDER
 REPLACEMENT NEW POOL

PLEASE CHECK APPROPRIATE LINER SHAPE:

Note: Width (A) view is standing at shallow end, facing deep end.

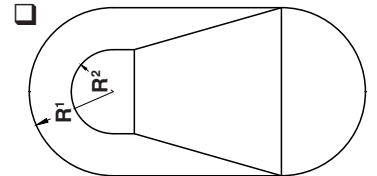
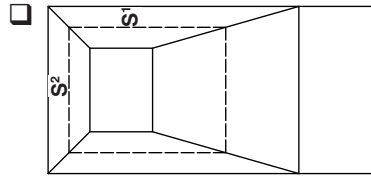
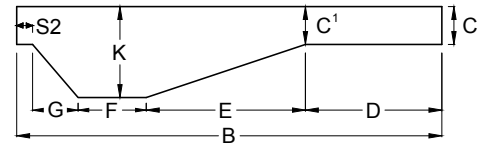
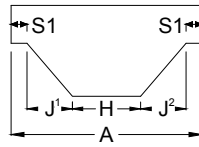

PLEASE USE APPROPRIATE ORDER FORM FOR THE FOLLOWING SHAPES:

- Decagon Jewel Rectangle True L
 Freeform Keyhole Rectangle Lazy L
 Grecian Kidney Roman End
 Grecian Lazy L Octagon

CORNER TYPE

- Square Diagonal Radius

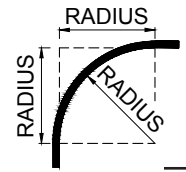
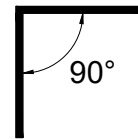

DATE: _____ PO#: _____

JOB NAME: _____

ORDERED BY

COMPANY: _____

CONTACT: _____

ADDRESS: _____

CITY/STATE: _____ ZIP: _____

PHONE: _____ FAX: _____

E-MAIL: _____

SHIP TO

NAME: _____

ADDRESS: _____

CITY/STATE: _____ ZIP: _____

PHONE: _____ FAX: _____

SHIP VIA: _____

Special Instructions: _____

POOL SIZE: _____ ft. _____ in. x _____ ft. _____ in.

SHAPE: _____

IMPERIAL DRAWING FILE #: _____

WALL PATTERN: _____ Mil: _____

FLOOR PATTERN: _____ Mil: _____

****If mil is not specified, Standard mil will apply****

LINER ATTACHMENT TO WALL:

- Beaded Multibead
 Overlap Other _____

SAFETY LEDGE:

- Yes (Fill in S¹ and S²)
 No

- AG Material IG Material Provide Drawing for Approval

- Detailed Pool Drawing with Specs Included

FOR OFFICE USE ONLY

DLR: _____

ORDER #: _____

PRODUCTION #: _____

DATE: _____

Please double check that:

J + H + J = A _____

D + E + F + G = B _____

STAIR RISERS = C _____

DIMENSIONS:

A: _____ ft _____ in

B: _____ ft _____ in

C: _____ ft _____ in

C¹: _____ ft _____ in

D: _____ ft _____ in

E: _____ ft _____ in

F: _____ ft _____ in

G: _____ ft _____ in

H: _____ ft _____ in

J¹: _____ ft _____ in

J²: _____ ft _____ in

K: _____ ft _____ in

S¹: _____ ft _____ in

S²: _____ ft _____ in

R¹: _____ ft _____ in

R²: _____ ft _____ in

PLASTIC STAIRS

- Radius Straight No Stair

Size: _____

Wall Seam Loc.: _____

STEEL STAIRS (Send drawing)

- Radius Straight

Mfg.: _____

Size: _____ Year: _____

Corner: 90° 6" Radius

Position:

- CSE 4-CRN-L
 3-CRN-L 4-CRN-R

3-CRN-R

OTHER (Send drawing)

Color: _____

- Rod Loop Bead None

CUDDLE COVE (Send drawing)

Size/Position: _____

Color: _____

- Rod Loop Bead None

The prompt production and delivery of your liner will depend on the accuracy and completeness of this request. No custom liner will be started unless all information is complete. ONLY COMPLETE AND LEGIBLE ORDERS WILL BE PROCESSED! A Vinyl Works order form must be used to be eligible for Liner Guard approved reimbursement.

I hereby authorize Vinyl Works, Inc. to produce, as a special order, a vinyl liner for an inground pool in accordance with the design provided and acknowledge that Vinyl Works, Inc. has not participated in either the design or specifications of this liner and accept full responsibility for the same. I further agree not to hold Vinyl Works, Inc. liable. I will pay in full for any and all claims and expenses that may arise out of the design or use of said special liner.

SIGNED: _____



STAIR LAYOUT LINER FORM

DATE: _____ PO#: _____
 JOB NAME: _____

ORDERED BY

COMPANY: _____
 CONTACT: _____
 ADDRESS: _____
 CITY/STATE: _____ ZIP: _____
 PHONE: _____ FAX: _____
 E-MAIL: _____
 Special Instructions: _____

ATTACHMENT: Beaded Rod Loops None

SIZE: _____ **YEAR:** _____ **OFFSET:** _____
 Straight Radius Thermoplastic **From Corner*

STAIR POSITION (Check box below):

Right
(4 Corner)

Right
(3 Corner)

**Offset*

Note: Stair position is always standing in the shallow end, and facing the deep end

Left
(4 Corner)

Left
(3 Corner)

**Offset*

Center

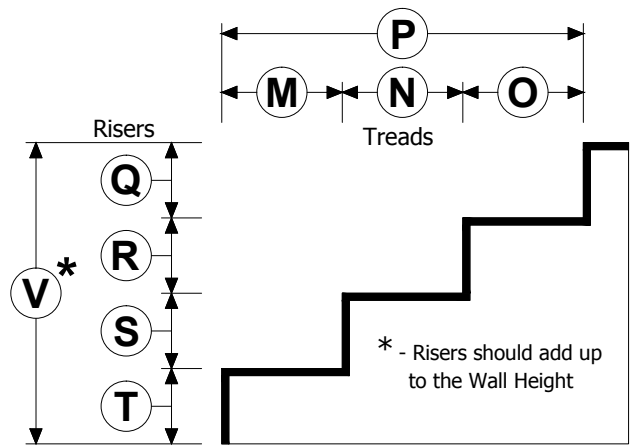

Coping Attachment: Side Mount *It is necessary to notify The Vinyl Works when side mount (vertical) extrusion is used. If not checked, Top Mount will be used.*

RISER MEASUREMENTS	TREAD MEASUREMENTS
Q _____	M _____
R _____	N _____
S _____	O _____
T _____	P _____
V _____	

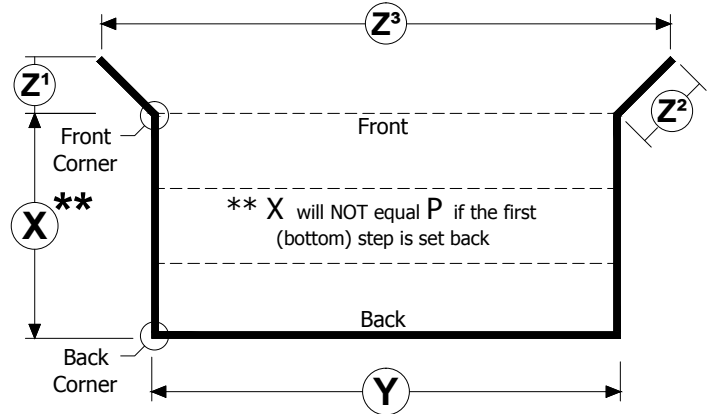

STAIR DEPTH	STAIR WIDTH
X _____	Y _____
STAIR SETBACK (IF APPLICABLE)	
Z ¹ _____	Z ² _____
Z ³ _____	

FRONT CORNERS: _____
BACK CORNERS: _____
MFG.: _____
COLOR: _____

FOR OFFICE USE ONLY

DLR: _____
 ORDER #: _____
 PRODUCTION #: _____
 DATE: _____

The prompt production and delivery of your liner will depend on the accuracy and completeness of this request. No custom liner will be started unless all information is complete. ONLY COMPLETE AND LEGIBLE ORDERS WILL BE PROCESSED! A Vinyl Works order form must be used to be eligible for Liner Guard approved reimbursement.

I hereby authorize Vinyl Works, Inc. to produce, as a special order, a vinyl liner for an inground pool in accordance with the design provided and acknowledge that Vinyl Works, Inc. has not participated in either the design or specifications of this liner and accept full responsibility for the same. I further agree not to hold Vinyl Works, Inc. liable. I will pay in full for any and all claims and expenses that may arise out of the design or use of said special liner.

SIGNED: _____

